

OBSERVATIONS WITH A PINHOLE CAMERA

Sakari Ekko

EAAE Summer School Working Group (Finland)

Abstract

In this workshop, students build a pinhole camera and use it to draw the changing position of the Sun on the screen. They determine the distance of the Sun with a long-focus pinhole camera, and the use of a pinhole camera to photograph the path of the Sun and Moon is discussed with some practical and theoretical tips.

INTRODUCTION

A pinhole camera is the simplest possible camera. Students can build it from inexpensive or waste material. In astronomy teaching, it can be used in many ways, such as imaging the path of the Sun or Moon and finding size-distance relations. The pinhole image is saved either photographically or by drawing it on tracing paper. You can add a simple meniscus lens to get a brighter image (this is not exactly a pinhole camera, but it is useful if you want to draw the image).

In addition, a pinhole camera is a great way to demonstrate the linear propagation of light and the photographic process - and pinhole photography is fun!

BUILDING A PINHOLE CAMERA

Camera obscura means “dark room”. A light-tight box with a pinhole in one end is a pinhole camera. Opposite the pinhole is the light-sensitive material. A piece of black tape acts as a shutter. The camera is loaded and unloaded in total darkness or, if you use enlarging paper, in red darkroom light. The camera must be on firm ground or a tripod during the exposure, because the exposure can take minutes or even hours.

First, we have to find or build the box. My students have built big pinhole cameras for 18 cm × 24 cm enlarging print paper, from copying paper boxes. In Figure 1 is a drawing to build an “A4 pinhole camera”, made from A4 size piece of cardboard. This model is best suited for drawing the image on a tracing paper screen. Of course, you can make it bigger by enlarging the drawings on a photocopier. Cut the parts from the template drawing and glue them on the cardboard using water-free glue. If you want to make photographs, build the pinhole camera in Figure 2. Shull describes this kind of camera in his book “Beginner’s Guide to Pinhole Photography”.

The box must be matt black inside to avoid reflections. Use black cardboard or spray paint the inside with matt black paint.

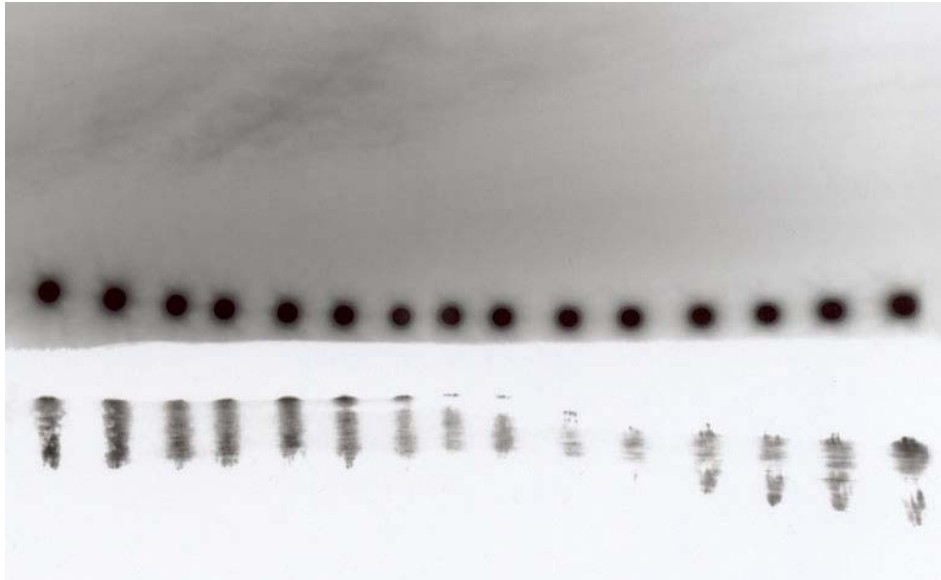

Figure 1. Midnight Sun 23.6.2002 at 68.5° N. F:310 pinhole camera, paper negative. Water reflections add visual interest



Figure 2. A drawing from the screen of a lens camera, made at the same time as Figure 1

The best material for the pinhole is a piece of a single-use aluminium pie pan. The pinhole must be round, thin-sided and the correct diameter. The diameter is not very critical, though, if your main purpose is not to make as sharp pictures as possible, 0.3 – 0.5 mm is good for a small camera (“focal length”, the distance from the pinhole to the imaging plane, about 50 – 120 mm) and 0.6 – 1.0 mm for a bigger camera (150 – 300 mm focal length).

Use a piece of cardboard under the aluminium sheet and push a needle lightly against the sheet, turning the sheet around the needle to get a circular hole. Do not force the needle all the way through if you want to get a smaller pinhole. The hole has blurs on the underside due to bending of the aluminium, and this can cause extra diffraction. Gently sand away the blurs using extra fine (grit 600) sandpaper. Check the roundness of the hole with a magnifier and repeat the procedure from the other side if necessary. If you have a measuring loupe, you can measure the diameter of the pinhole to calculate the f-number (see later). Measuring the diameter of the needle you used to make the pinhole gives a good estimate too.

Make a hole about 4×4 mm square in the upper part of the front panel and tape the pinhole centrally over it with black tape. If the pinhole is near the upper edge of the

“lens board” and the camera is level, you get the horizon in the lowest part of the image (or in the uppermost part of the tracing paper screen, because the image is upside down in the camera). Thus, most of the image area is sky – and the sky is our object. With the camera levelled, the horizon in the image is at the same height as the pinhole, and you can draw it on the screen without seeing it. Try to get the pinhole accurately at the level of the horizon line in the back of the camera.

PHOTOGRAPHING WITH A PINHOLE CAMERA

Materials needed:

- Darkened room
- Pinhole camera
- Scissors and black tape
- Matt or semi-matt enlarging paper (I use Ilford Multigrade IV 44M; a matt or semi-matt surface causes less reflections than glossy one)
- Paper developer
- Fixer
- Two trays, one for developer, one for fixer. You can make temporary trays from suitably sized cardboard lids with a piece of plastic sheet over them
- Red safelight (an indirect light from a rear LED light for bicycles will do)
- Water for rinsing.

In the darkroom, cut a sheet of enlarging paper to match the back of your camera. Tape the enlarging paper into the back of the camera making sure the lightly shiny emulsion side is towards the pinhole, secure the lid with black tape, close the shutter tape and take the camera outside. Point it the using lines drawn on the box from the locations of the enlarging paper edges to the position of the pinhole. Level it using a spirit (bubble) level or align the upper edges of the box with the horizon. Secure the camera on a tripod, table or some other platform with blue-tack or tape, then open the shutter for some seconds or several minutes, even hours, depending on the light level. Snapshots are not possible with a pinhole camera!

The speed of enlarging paper is about ISO 6, so it needs 16 times the exposure for ISO 100, and the f-number of the pinhole is about 200-300, allowing $(200:2.8)^2 = 5100$ to $(300:2.8)^2 = 12000$ times less light to reach the film than a f:2.8 lens. Thus the paper negative needs about 80 000 to 200 000 more time to expose the paper than your camera at ISO 100 f:2.8. See Formulae. So, if your digital camera indicates an exposure of 1/1000 s f:2,8, the pinhole camera needs 80 to 200 seconds. You can use your camera as a light meter, but you have to gain experience with your pinhole camera to get it right. Make experiments, and soon you will be familiar with your camera and learn to estimate the right exposure. It is like in the good old times before light meters and auto exposure!

After the estimated exposure time, close the shutter tape and take the camera into the darkroom. Dilute the developer and fixer with water following the instructions on the bottle and pour them into their trays. Take the paper from the camera in red darkroom light and develop it for one minute, rinse in water some seconds and fix about 2 minutes, then rinse in water for 2-5 minutes and let dry. Remember to agitate the paper during the process.

You have your first pinhole paper negative. If the negative image is too dark, the exposure time has been too long; if too light, you have to expose for longer. Experiment until you have a good negative and scan it on a flatbed scanner. You can process the image further in a computer. Image>Adjustments>Invert will give you a positive. You can make a positive by photographic contact printing, but digital scanning and processing is easier and gives more control.



Figure 3. A 4 hour exposure with a f:310 pinhole camera, Baader Astrosolar filter. From a paper negative. Taken on 6.2.2007 at 60.5° N. The exposure began about 30 minutes after local noon. The horizon is in the lowest edge of the image

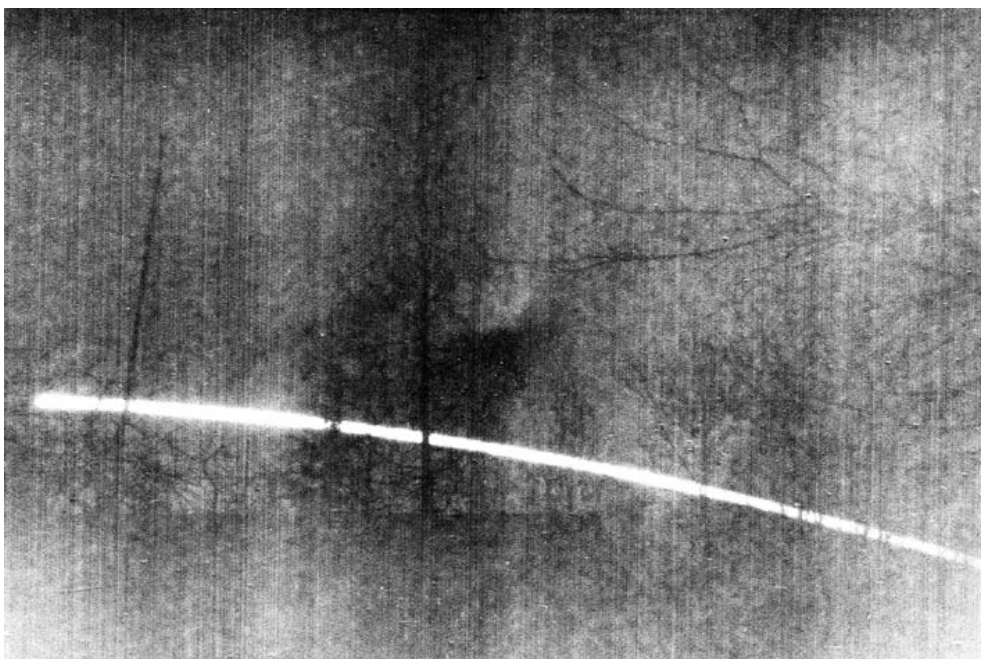

Figure 4. Same view as in Figure 3, f:240 pinhole camera, paper negative, no development

If this sounds too complicated, you can use enlarging paper without developing, but it needs very long exposure, hours and days. Enlarging paper will darken without development, when it gets enough light. You can scan it to get a permanent image, and then invert it (Figure 4 is a 4-hour exposure). The very low sensitivity of enlarging paper used this way can be an advantage: you do not need any filter when photographing the Sun.

A sheet of tracing paper can replace the back in a pinhole camera. Draw the position of the Sun on the paper with a felt pen, touching the screen only lightly with the tip of the pen; tracing paper bends easily and the image moves. Most other objects are too dark to see on the tracing paper screen. To see them, you have to use a dark cloth over your head and screen like the old-time photographers and maybe replace the pinhole with a simple lens of suitable focal length.

THE PATH OF THE SUN AND MOON

About 1 second is enough to get an image of the Sun's disc on the paper negative using a pinhole around f:300. A 4 to 8× (ND 0.6 to 0.9) neutral density filter helps if the Sun is very bright. Make multiple exposures with a tripod-mounted pinhole camera at 10-minute intervals, and when the Sun is out of the field take a background image with enough exposure to get the landscape in the image. Simple, but avoid overexposing the landscape. If the sky in the negative is pitch black, you can not see the images of the Sun.

Photographing the path of the Moon is simpler still. Due to the rotation of the Earth, the Moon moves on the paper negative the distance of its diameter in about 2 minutes. This exposes every part of a gibbous or full Moon's path correctly, and you can leave your camera on a tripod for hours to get the path on the negative. Close the shutter when ready, leave the camera as it is until morning and expose the landscape. Again, avoid overexposure. See Figure 5. You can make exposures on the same negative on successive nights, showing the changing path of the rising or setting Moon, but remember to close the shutter before dawn. You can screw, strap or clamp the pinhole camera on a wall, fence or pole for a long-term project like this. The camera must be made of weather-resistant material.

Undeveloped negative paper works in the same way, when photographing the Sun. Just leave the camera with the shutter open for days or months and scan the resulting negative. Baader Astrosolar ND5 (cuts the light to 1/100 000) filter will allow you to make a time exposure of the Sun like the Moon exposure above. Just tape a small piece of filter foil over the pinhole and expose as long as the Sun is in the field, then take the filter away and expose the landscape. See Figure 3.

I am writing this in February, and soon there will be a lunar eclipse. Weather permitting, I will try my pinhole camera on it. Probably the Moon will be totally lost during the umbral phase.

It would be an interesting international school project to compare the path of the Sun or Moon at different latitudes during the year. The declination of the Moon varies during lunation. Taking images of the rising or setting Moon on the same evening in different

locations during one month and sharing the images with participating groups is very instructive. The path of the Moon has a different curve depending on its declination, and its rising angle depends on the latitude. The same is true for the Sun, of course, but its declination varies more slowly.

THE DISTANCE OF THE SUN

The size-distance-relationship is easy to demonstrate with a pinhole camera. Photograph or measure on the screen (a lens camera is better for visual measuring) objects at different distances and use simple geometry to find how the size of the image depends on the distance of the object, the size of the object and on the focal length of the camera.

Make a pinhole camera from a one-metre long cardboard tube, with a 1-2 mm pinhole and tracing paper screen. If you replace the pinhole with a +1 dioptre spectacle lens with a 5 mm aperture, you get a sharper and brighter image. Point the camera to the Sun and measure the diameter of the Sun's disc on the screen. You can photograph the Sun too, but the tube camera is very difficult to aim.

If the real diameter of the Sun is known, the distance is easy to determine from the diameter of the image and the focal length. Once I found a 2.7 m tube to make a camera, and my group drew a lot of attention in the schoolyard with it. The diameter of the pinhole was about 3-4 mm.



Figure 5. Moonrise on 3.2.2007 at 60.7° N. F:240 pinhole camera, from paper negative, no filter. First, clouds obscured parts of the line, and then fog dimmed the last part. Let's hope better weather next time!

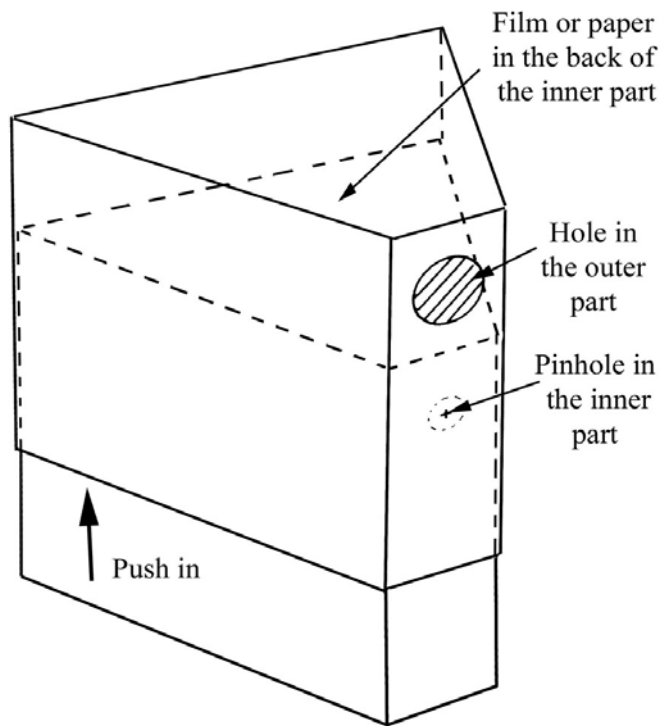

Figure 6a. A pinhole camera for photographing

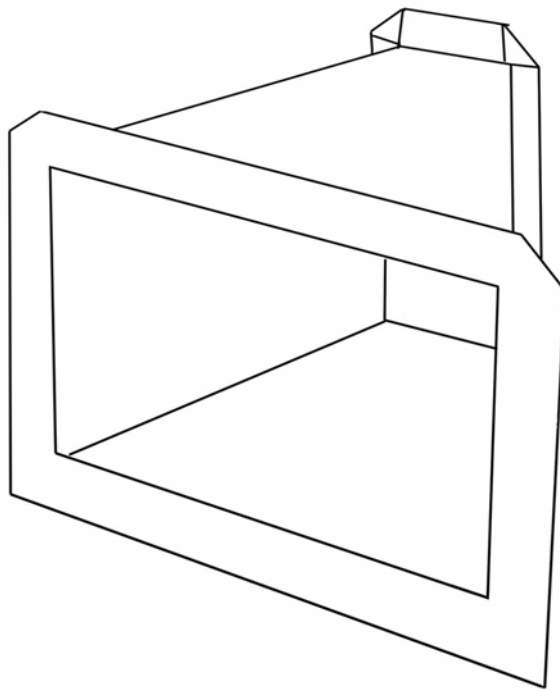

Figure 6b. A pinhole camera for drawing

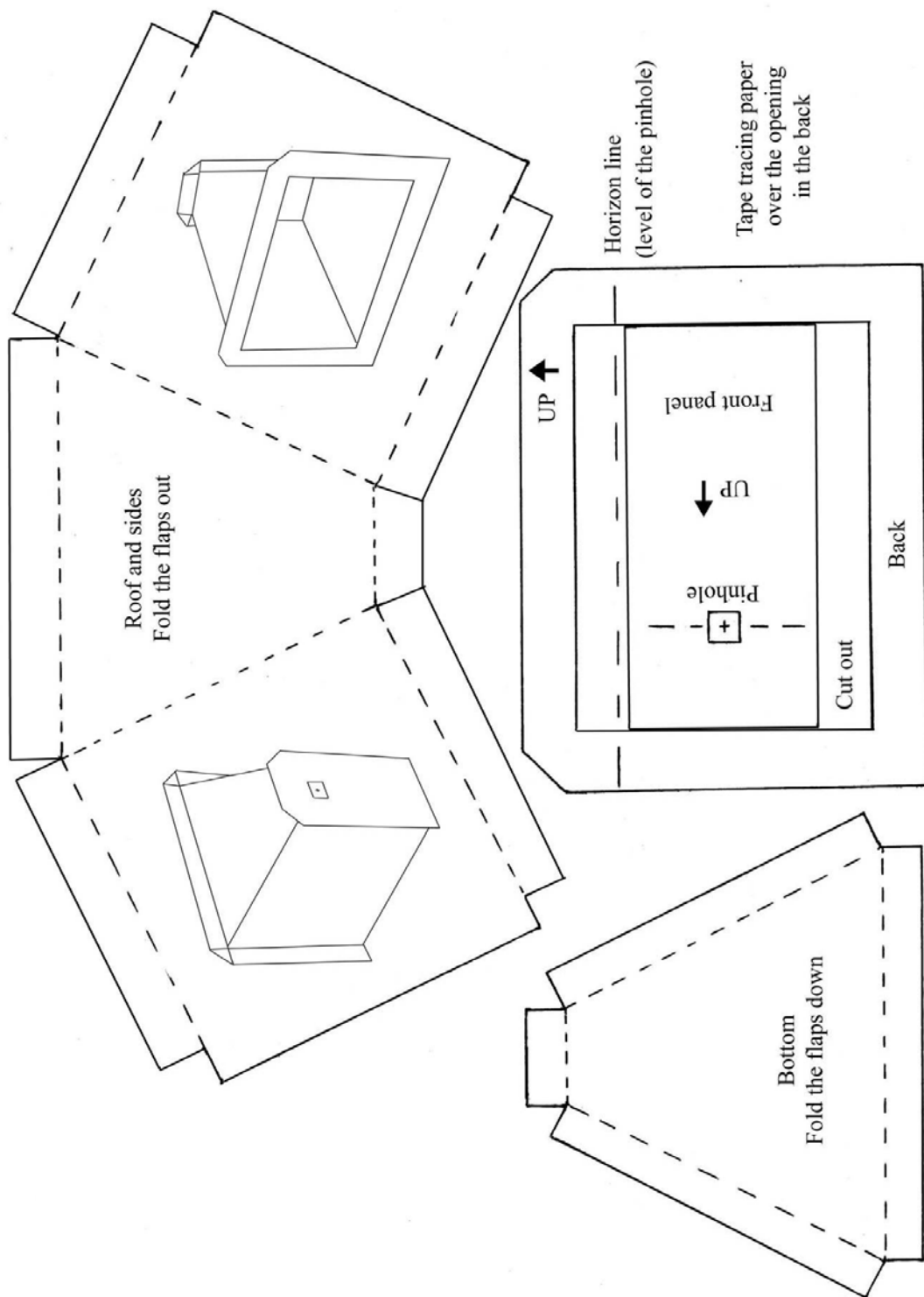

Figure 7. A4 Pinhole camera

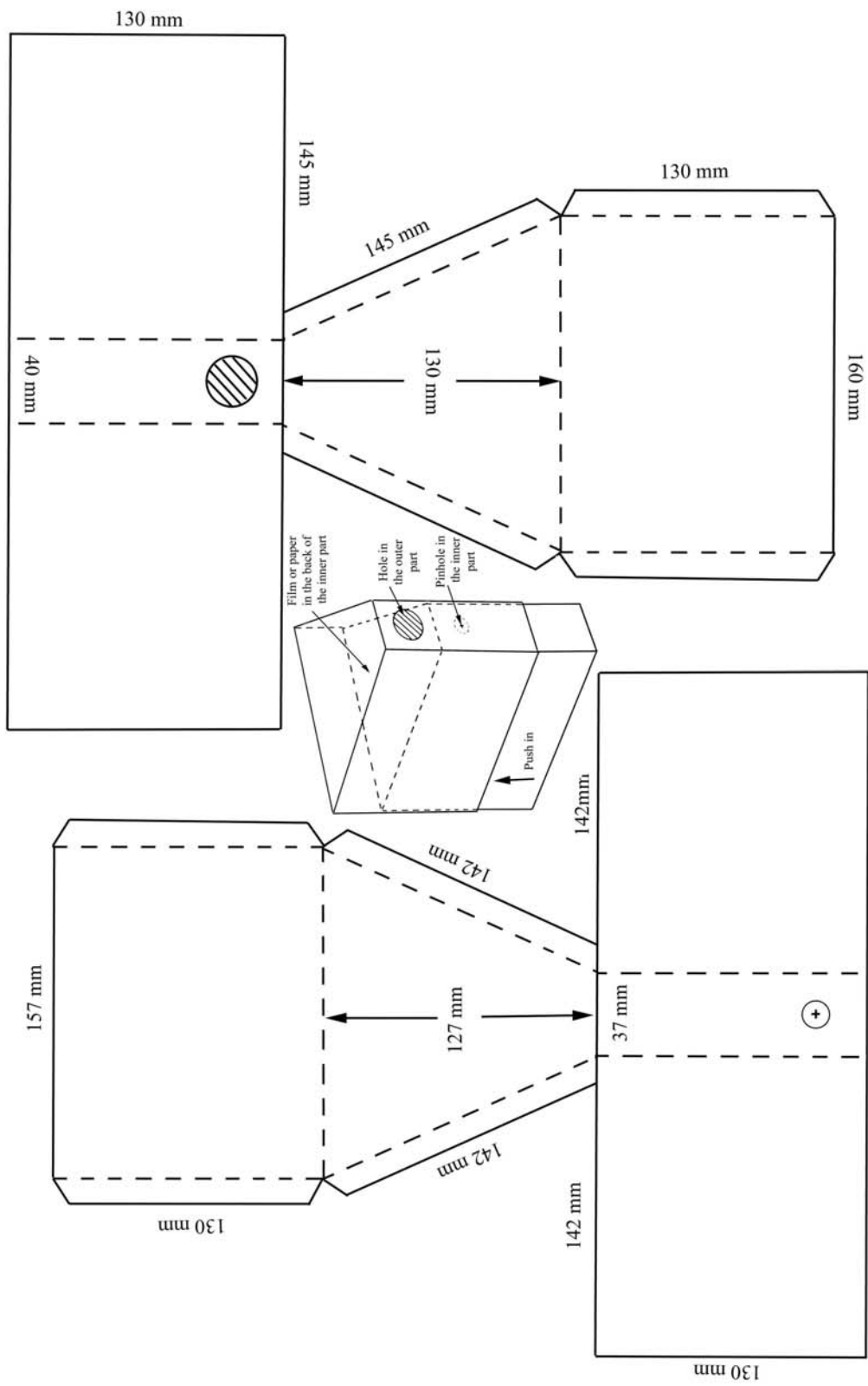

Figure 8. Photographic pinhole camera

You can estimate the distance of a galaxy with the same method, but you have to make a lens photograph of the galaxy. A pinhole camera is far too slow for deep sky imaging.

FORMULAE

The aperture of a camera is the diameter (d) of the lens opening and the focal length (f) is the distance of the lens from the film. The f-number is the focal length divided by the aperture

$$\text{f-number} = \frac{f}{d}$$

For example, if the pinhole diameter is 0.50 mm and focal length is 150 mm, the f-number is:

$$150 \text{ mm} / 0.50 \text{ mm} = 300, \text{ written as f:300}$$

In common cameras, the f-numbers in the iris of the lens are arranged in following series:

Table 1. "Exposure factor"

f-number	2.8	4	5.6	8	11	16	22	32	45	64	90	128	180	256	360
Exposure factor	1x	2x	4x	8x	16x	32x	64x	128x	256x	512x	1024x	2048x	4096x	8200x	16400x

For every step the light reaching the film or chip is halved. So, if the exposure is right at f:2.8 and 1/1000 s, with f:64 you need $256 \times (1/1000 \text{ s}) = 0.256 \text{ s}$ or about $\frac{1}{4} \text{ s}$ to get the same exposure. You can calculate the exposure factor:

$$\text{Exposure factor} = (\text{f-number } 2 / \text{f/number } 1)^2$$

The exposure factor for a f:300 pinhole, compared to f:2.8, is $(300:2.8)^2 = \text{about } 11\,500$. Note: photographic emulsions tend to lose sensitivity in long exposures, but we neglect it here, because you have to make trial exposures with your camera anyway to find the right exposure.

When the sensitivity doubles, the ISO number doubles, and vice versa:

Table 2. "ISO number and Exposure factor"

ISO	6	12	25	50	100	200
Exposure factor	16x	8x	4x	2x	1x	0.5x

ISO 6 enlarging paper needs 16 times the exposure for an ISO 100 film or chip when the same f-number is used.

The f:300 pinhole camera using ISO 6 enlarging paper needs $16 \times 11\,500 = 184\,000$ times the exposure at f:2.8 ISO 100!

An example: Your camera or light meter indicates f:5.6 1/500 s at ISO 100. For ISO 6 f:300 you have to expose $16 \times (300/5.6)^2 \times 1/500 \text{ s} = \text{about } 90 \text{ s}$ or 1.5 minutes.

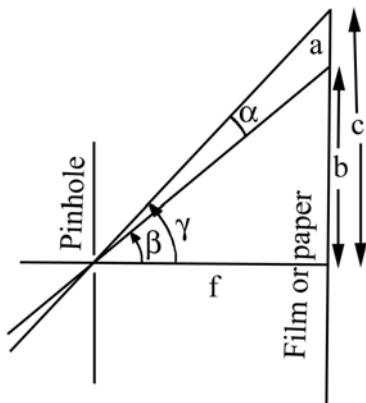

The scale of the image opposite the pinhole is different from the scale in the corners. Image is stretched towards the corners:

$$a = c - b = f \tan \gamma - f \tan \beta$$

$$\alpha = \gamma - \beta = \arctan (c/f) - \arctan (b/f)$$

If your camera is a wide-angle pinhole camera (f is shorter than the diagonal of the image), this effect is more pronounced, as well as the darkening towards the edges (see Figure 3 or 5).

References

- Renner, Eric: Pinhole Photography – rediscovering a Historic Technique, Focal Press 1995.
- Shull, Jim: The Beginner's Guide to Pinhole Photography, Amherst Media 1999.